

ALESIS 3630

Reference Manual

1.1 INTRODUCTION

Thank you for purchasing the Alesis 3630 Dual Channel Compressor/Limiter with Gate. This cost-effective gain control device complements any studio with several important features. For more information on the significance of these features, refer to the Appendix "About Compression and Limiting."

- **Stereo or dual mono operation.** The 3630 can serve as two totally independent units, or both sections can be strapped together for stereo operation. In stereo, gain changes in one section are "tracked" by the other section to eliminate wandering of the stereo image.
- **Peak or RMS response.** Determines whether the limiter will base its operation on signal peaks or average signal levels. Each has its uses with different types of signals (for example, peak with drums, and average with complex program material).
- **"Hard knee" or "soft knee" response.** Each type of response gives a different limiting action. The hard knee response is generally considered more "severe," and the soft knee response, more "musical."
- **Individual bypass switches for each channel.** This makes it easy to compare the processed and unprocessed sounds.
- **Side chain connections.** Insert EQs and other devices for applications such as de-essing (removing sibilance), adding treble to limited signals, "keying" one signal with another, "ducking" (e.g., making a signal such as background music become lower in volume in response to another signal, such as narration), and other applications.
- **+4 dBu or -10dBV operation.** This provides signal level compatibility with nearly all studio setups.
- **Front panel knob calibrations.** Knobs are calibrated to allow for easy setup and operation.
- **Built-in stereo/dual mono noise gate.** This can reduce noise when compressing or limiting. Each section can also operate as a stand-alone noise gate.
- **Extensive metering.** Each channel has a 12-LED display to indicate the amount of gain reduction, a second 12-LED display to show input/output levels, and a dual-LED display to indicate noise gate status.

Here are some typical applications for the 3630:

- Even out a vocalist's dynamics to compensate for poor mic or vocal technique.
- Increase a guitar's (or other stringed instrument's) sustain.
- Smooth out bass sounds for a more consistent level.
- Prevent peaks common in many source signals, such as drums, from overloading tape during recording.
- Minimize the chance of speaker burnout by inserting a limiter prior to the power amp.
- Decrease a signal's dynamic range to accommodate a recording medium with a more limited dynamic range (e.g., process a master tape mixed for CD duplication when making cassette copies to accommodate the cassette's limited dynamic range).
- In PA applications, limiting can increase a vocalist's level before feedback occurs.
- Reduce sharp signal peaks associated with some signal processors and highly resonant synthesizer patches.
- Remove hiss from tape, guitar amps, etc. with the noise gates.
- Use the noise gate to "key" one instrument's rhythm to another instrument.
- Use the sidechain to remove excessive sibilance from vocals and narration (commonly known as "de-essing").
- Use the sidechain for lowering background music or other program material in the presence of narration (commonly known as ducking).

1.2 HOOKUP: GENERAL TIPS

(diagram of rear panel inserts here)

Rear Panel Connections

Each channel has its own set of rear panel 1/4" phone jacks.

Input Plug in the output of low or line level signals to be limited, compressed, or gated. These outputs can be a stereo pair or individual mono outputs from mixing consoles, crossovers, tape recorder chan-

nels, synthesizers, and other unbalanced signal sources.

Microphones and guitars can be used with the level switch set to -10dBV (see below). Guitars with exceptionally low output pickups may require a preamp for best results. The input impedance is greater than 100k Ω .

Side chain This stereo jack allows for insertion of other signal processors or "keying" from other signal sources. See section 1.8 for side chain applications.

Output Provides the processed (compressed/limited/gated) output. The output impedance is 470 Ω , unbalanced. Output level covers a nominal -20 to +20 dB range.

+4 dBu or -10dBV switch Use this switch to match each channel of the 3630 to the rest of your gear. Generally equipment designed for larger pro studios tend to use +4 dBu nominal signal levels. Equipment designed for smaller project and home studios and electronic musical instruments tend to use -10dBV nominal signal levels. If the input signal doesn't provide enough drive to the LED meters, use the -10dBV position. If distortion occurs, use the +4 dBu position.

Changing the switch position modifies the way the input/output meter references signals. When set to the +4 dBu position, a 4 dBu input signal reads 0 dB on the input/output meter. When set to the -10dBV position, a -10dBV input signal reads 0 dB on the input/output meter. When the unit is set up for unity gain (no compression, output at 0) the input level will be equal to the output level regardless of the position of the +4 dBu/-10 dBV switch.

Installation

For most applications the 3630 will be installed in a rack frame. The 3630 generates very little heat so it is not necessary to leave an empty space for ventilation above or below the unit.

1.3 HOOKING UP POWER

Hooking up power involves the rear panel power jack and front panel on-off switch.

Power jack Plug the AC adapter output in here. Use only the AC adapter supplied with the 3630; use of any other AC adapter will void your warranty. To prolong the AC adapter's life, unplug it when not in use (turning the 3630's power switch to off is not sufficient to disconnect the AC adapter from AC power). Alesis recommends plugging your AC-powered devices into a switched barrier strip, so that turning off the barrier strip turns off power to your gear.

On/Off switch Press in to turn on. Press again (switch goes to the out position) to turn off.

1.4 FRONT PANEL COMPRESSOR/ LIMITER CONTROLS

(front panel diagram inserts here)

The front panel controls for the two compressor/limiter channels are identical. The Channel A controls are located between the power switch and Stereo Link switch in the middle of the panel. The Channel B controls are located to the right of the Stereo Link switch. The Stereo Link switch controls whether the two channels will operate as a stereo limiter or two mono limiters, as described in section 1.5.

Since both channel controls operate identically, only the left channel controls will be described.

Important: If you are not familiar with compressors, limiters, and noise gates, refer to the Appendix. It contains theory necessary to understand the following control descriptions.

Threshold (-40 to +20 dBu)

Sets the level above which signals will be compressed or limited. Rotating the control clockwise raises the threshold, thus clamping signals at a higher level and reducing the amount of compression or limiting.

Ratio (1:1 to ∞ :1)

Sets the compression *slope*, which determines how the output signal will change in relation to the input signal once the input signal exceeds the threshold. The first digit indicates how many dB of input change will cause a 1 dB output change. The higher the ratio, the greater the compression, and the more "squeezed" the sound.

Examples: With a setting of 2:1, a 2 dB input change for signals above the threshold results in a 1 dB output change. With a setting of 1:1, a 1 dB input change results in a 1dB output change (*i.e.*, there is no change to the signal dynamics). With a setting of ∞ :1, the output level remains virtually constant regardless of input level changes.

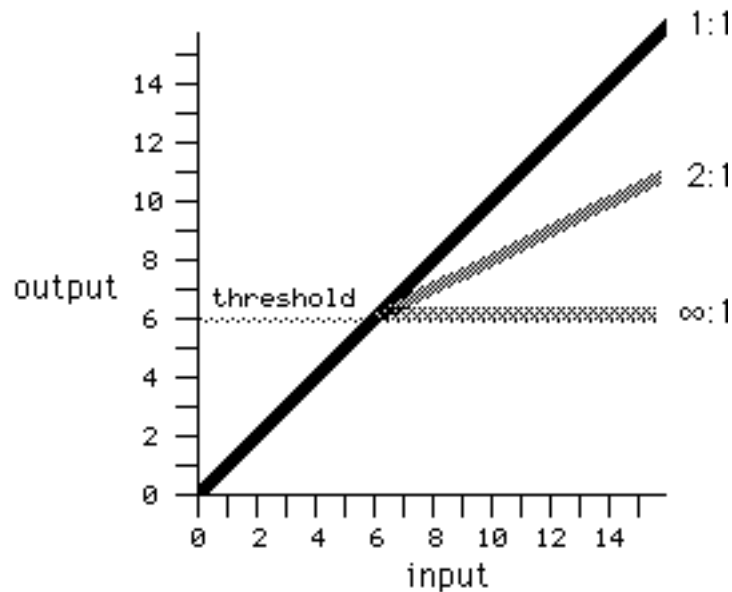

Attack (0.1 ms to 200 ms)

This control works *only* with the Peak/RMS switch (section 1.5) in

Peak mode. RMS mode automatically adjusts the attack time, depending on the characteristics of the signals being processed.

In *peak mode*, this control sets how fast the limiter's internal circuitry reacts to changes in input level. The longer the attack time, the more of a signal's dynamics are "let through" before the limiting action kicks in. With slower attack times, the limiter responds more to average signal level. This produces a smoother sound that tends to retain dynamic character, but the tradeoff is that the 3630 cannot react as rapidly to sudden level shifts.

Examples: Setting a longer attack time with guitar allows more of the pick attack to come through. A longer attack time with kick drum lets through more of the beater "thock." For recording, you may want to trade off response time for smoothness. When used to prevent loudspeaker or power amp clipping, a fast attack time is desirable.

Release (50 ms to 3 seconds)

This control works *only* with the Peak/RMS switch (section 1.5) in *Peak mode*. RMS mode automatically adjusts the release time, depending on the characteristics of the signals being processed.

In *peak mode*, this control determines how long it takes for the limiter to return to unity gain after going into limiting. With short release times, the limiter tracks every little change in level, producing a potentially uneven or "rippling" effect that decreases dynamics but increases the average output level. Longer release times tend to "squash" the signal more, producing less overall output but retaining more of the signal's dynamics.

Excessive release times can be used as an effect. In the 60s using lots of limiting with long release time on drums was a popular recording technique.

Output (-20 to +20 dB)

The process of reducing dynamics lowers the signal's overall level. Use this control to compensate by adding output gain.

Example: Limiting a signal by 6 dB will make the signal seem approximately 6 dB softer. Compensate by using this control to increase the level.

1.5 FRONT PANEL

COMPRESSOR/LIMITER SWITCHES

Each switch has an in and out position. The legend above each switch shows which status is associated with which switch position.

Peak - RMS

With peak response, the 3630 responds to signal peaks to insure that these peaks do not exceed a particular threshold. This mode is ideal when using the 3630 to avoid *clipping*, a phenomenon when signal peaks exceed a particular device's headroom. In RMS mode, the 3630 responds to a signal's average level. This preserves more of the relationship between a signal's peaks and valleys, and is useful when you want to compress or limit but still retain a fair amount of dynamic feel. *Note:* in RMS mode, the attack and release times will be program dependent. The front panel attack and release controls will have no effect on the signal.

Hard knee - Soft knee

With hard knee response, signals are clamped to the limiting threshold as soon as they exceed it. With soft knee response, signals are clamped more gently, giving a more natural sound.

Input - Output

Selects whether the input/output meter displays the input signal or output signal. See section 1.7, Front Panel Metering, for more information.

Bypass - Comp

In the bypass position (the gain reduction LEDs will turn off), the limiter circuitry is switched out of the signal path so you can hear the unprocessed sound. In the Comp position, the 3630 processes the input signal.

Note: The 3630 must be powered up to pass a signal with either switch setting.

Stereo Link Switch

In stereo operation, both channels need to operate in a complementary fashion to avoid shifting the stereo image as one channel or the other

goes into limiting. With the Link switch out, Channels A and B operate independently as two monophonic compressor/limiters.

With the Link switch in, Channel A's controls become master controls for Channels A and B, with the exception of the input/output and the +4 dBu/-10 dBV switches which will continue to operate independently. The stereo signal is processed identically by both channels to preserve proper stereo imaging.

While in stereo mode, the compressor and gate control signals are derived from a combination of Channel A and Channel B inputs. Compression and gating are not solely dependent upon the input signal present at Channel A (the master channel). For example, an input signal on either Channel A or Channel B will cause compression to occur (and/or open both gates) once it rises above the threshold set by Channel A controls, even if there is no input signal present on the opposite channel.

For stereo sidechain applications, please refer to Section 1.8.

1.6 FRONT PANEL

NOISE GATE CONTROLS

The noise gate will not pass signals below the specified threshold setting, but signals above the threshold will pass unaffected. In a typical application, the threshold would be set just above any residual hiss or noise. Thus with no signal going through the 3630, no hiss would be audible. A signal going through the 3630 would pass through unimpeded. The hiss would also be present under these conditions, but since a strong signal is present it would tend to "mask" the hiss.

To use the 3630 solely as a noise gate, set the Ratio control to 1:1. This passes the input signal to the noise gate without processing.

Threshold (no gating to -10dBV)

Sets the level above which the noise gate will allow signals to pass. Turning the Threshold fully counter-clockwise disables the noise gate and lets the signal through unaltered.

To set the proper gate level for most applications, turn the Gate

Threshold to OFF. Turn on all instruments to be gated but do not pass program material through them (For example, turn your microphone on but do not sing through it). Increase the Threshold (clockwise) until the red CLOSE LED comes on. Any background noise should now be eliminated.

Example: To remove hiss from a guitar amp signal, set the Threshold just above the residual hiss while muting the guitar strings. Playing guitar should produce a signal higher than the threshold, letting through the notes. When the guitar is not playing, the residual hiss signal should be below the threshold, closing the gate.

Rate (20 ms to 2 seconds)

When a signal dips below the threshold, Rate determines how long it takes for the gate to fade smoothly from the gate open to gate closed setting. Shorter settings provide maximum hiss reduction but tend to create a "choppier" sound. Longer settings gain a smoother response at the expense of possibly letting a little hiss come through after the input signal dips below the threshold.

1.7 FRONT PANEL METERING

The 3630's three meters for each channel indicate several important parameters.

Gain Reduction Meter (-1 to -30 dB)

This compares the processed and unprocessed sounds, and shows the amount of gain reduction being applied to the input signal.

Example: A meter reading of -6 dB indicates that the 3630 is attenuating the input signal by at least 6 dB in order to keep it at the threshold level. The more lights that are lit, the greater the amount of limiting, and the more processed the sound.

Input/Output Meter (-30 to +6 dBu)

This monitors the input or output signal, as selected by the Input/Output switch. This is useful when matching input and output levels, or to compare the signal level prior to limiting with the signal level that occurs after limiting.

Noise Gate Meter (Open or Closed)

When the noise gate is closed (*i.e.*, the input signal is below the noise gate threshold), the red Close LED is lit. When the noise gate is open and letting through the input (*i.e.*, the input signal is above the noise gate threshold), the green Open LED is lit. The red Close LED fades from on to off over the time set by the noise gate Rate control.

Since either the Open or Close LED will be on at all times, these also serve as power-on indicators.

1.8 SIDE CHAIN APPLICATIONS

The side chain jack allows for two useful functions:

- "Keying" one signal with another, so that the dynamics of one signal depend on the dynamics of a second signal
- Frequency-dependent limiting, so that limiting is triggered only by certain frequencies.

The side chain jack is a stereo jack, where the ring connection sends the 3630's control signal for processing, and the tip connection receives the processed sound. For keying applications, a regular mono cord can be used since it is not necessary to send the 3630's control signal out for processing. For frequency-dependent limiting applications that involve plugging into another signal processor, a special stereo-to-dual-mono cord is required, as shown below.

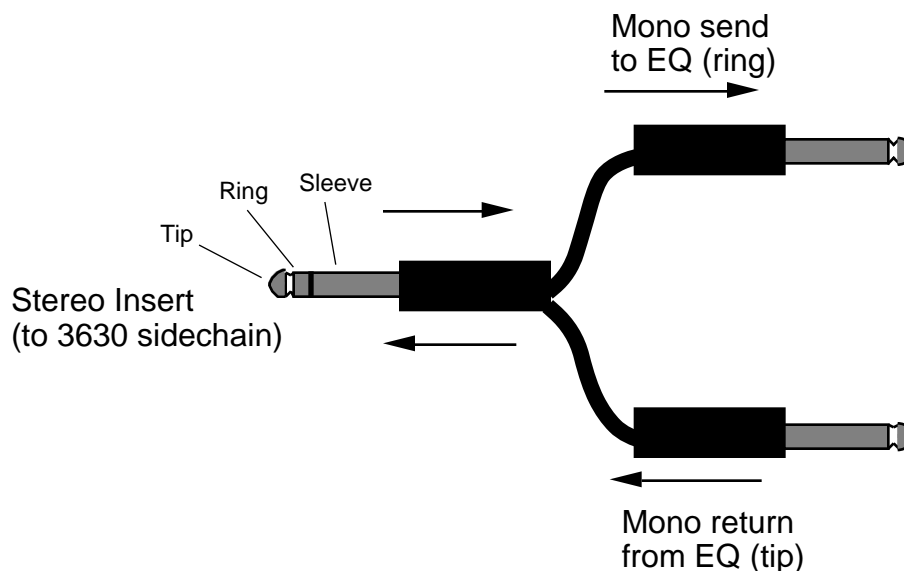

Keying Application: Ducking

A typical use of keying is to lower background music in the presence of narration. This is called *ducking* because the music "ducks" to get out of the way of the narration. A similar application would be to lower the level of a rhythm guitar while a vocalist is singing. To perform ducking:

1. Process the signal to be "ducked" (e.g., background music) through the 3630. For stereo signals use both channels, for mono signals just use one channel.
2. Plug the control signal (e.g., narration) into the channel's side chain jack, using a cord with a mono 1/4" phone plug.
3. The Threshold, Ratio, Attack, and Release controls now affect how much ducking will occur in response to the control signal. The Gain Reduction meter will show how much the "ducked" signal is being attenuated by the control signal.

Note: For stereo ducking using a single control source, the control source may be inserted into either side chain input. An unconnected 1/4" plug (stereo or mono) must be inserted into the other side chain input in order to disconnect the program material of that channel from the compressor/gate control circuitry.

Ducking. The signal at the sidechain's input (lead instrument or vocal) triggers the 3630, causing the stereo signal present at the inputs (background music) to be limited only when the lead instrument or vocal is present

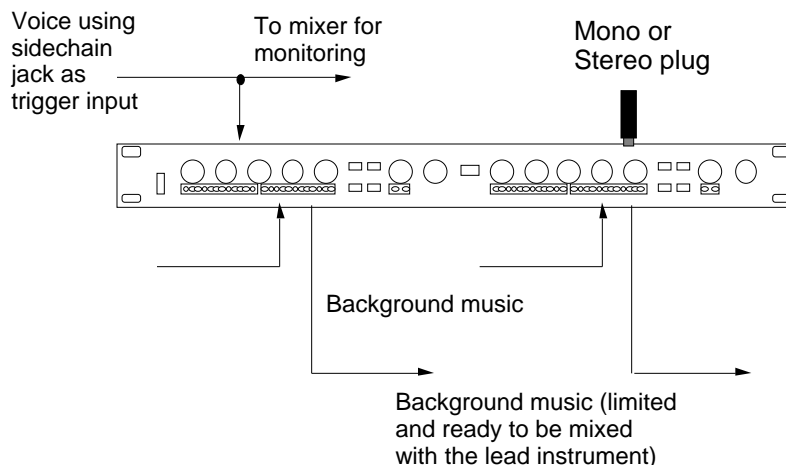

Frequency-Dependent Limiting Application: De-Essing

Some vocalists and announcers, especially if equalized for more treble, will produce excessive "sibilance" ("S" sounds, concentrated mostly in the upper midrange and treble). In this situation, the limiter would ideally limit the signal only when high frequency "S" sounds occur. This is possible by inserting an equalizer into the side chain jack.

This application requires the special stereo-to-dual-mono cord mentioned above and an equalizer, such as the Alesis MEQ 230.

1. Plug the cord's stereo plug into the 3630's side chain jack.
2. Plug the stereo cord's ring plug into the EQ's input.
3. Plug the stereo cord's tip plug into the EQ's output.
4. Increase the EQ gain in those bands whose frequencies should trigger limiting of the signal. For de-essing applications, try equalizer frequencies in the range of 2 kHz to 10 kHz. Setup for de-essing is quite easy. With a graphic equalizer, select a frequency (2K for example), and set up an excessive boost (as much as 12dB). If the chosen frequency is correct, the excessive gain at that frequency will trigger the compressor when overly sibilant passages occur. If you are successful, try adjacent frequencies one at a time to see which frequency gives the best results. With a parametric EQ, create an excessive boost in the 2kHz - 10kHz band, and sweep the frequency control until best results are obtained. Thus, the high frequency "S" sounds trigger program limiting more readily than the non-"S" sounds.
5. Adjust the Threshold, Ratio, Attack, Release, etc. for the desired degree of high-frequency limiting. In de-essing applications, it is your goal to set the attack and release times as fast as possible, so that the sibilant peaks are eliminated without any audible change in the program material.

Frequency Dependent Limiting (Stereo De-essing).
The EQ inserted into the 3630's sidechain insert allows excessive sibilance to be limited without affecting the rest of the program content

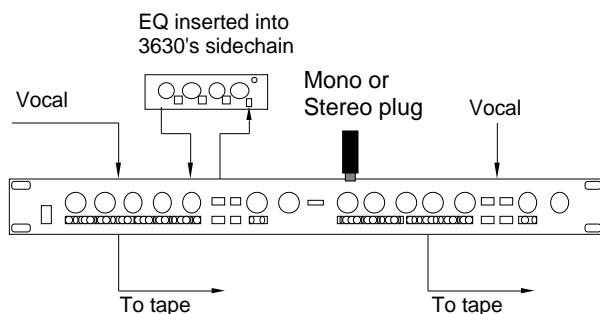

1.9 TROUBLESHOOTING

Noisy or "squeezed" sound- Too low a limiting threshold and/or too high a compression ratio can result in such problems as squeezed, unnatural sounds or excessive noise. Remember, limiting lowers the input signal's dynamic range. If the input signal has a dynamic range of 60 dB and you apply 15 dB of limiting (quite a lot), the dynamic range falls to 45 dB. This degrades the signal-to-noise ratio by an equal amount. A 60 dB signal to noise ratio can be acceptable; a 45 dB signal to noise ratio is audibly noisy.

If you encounter these types of problems, reduce the Ratio control or raise the Threshold control. Be careful; because the ear is not particularly sensitive to level changes, it is possible to add considerable amounts of limiting before it becomes obvious. Monitor the Gain Reduction meter to see how much limiting is being used, and adjust Threshold so that fewer LEDs light. Also, compare the bypassed and processed sounds to hear how much the 3630 affects the sound.

Some musicians use excessive limiting as an effect. Many of the monster drum sounds you hear in records by artists like Phil Collins and Peter Gabriel are due to heavy limiting, followed by high-threshold noise gating to create an abrupt cutoff.

Noisy source signal- A noisy source signal may become more noisy when processed. Use the 3630's onboard noise gates to quiet a noisy signal.

Overall noisy operation- If the +4/-10 switch is set to +4, try setting it to -10.

"Choppy" or "jittery" sound- If the sound is choppy or jittery and the 3630 is in peak mode, increase the Attack and/or Release times. There are no fixed rules for optimum times since different instruments will work best with different settings. Generally, low frequency instruments such as bass will require longer attack times.

Dull attack- The noise gate Threshold must be turned as far counter-clockwise as possible (with the gate still operating) to catch initial attack transients. The gate may appear to be working with a wide range of settings, but if the initial transient is being cut off, the signal may sound dull or lack "life."

Attack and Release controls have no effect- The 3630 must be in Peak mode for these controls to be active.

Heavy distortion- If the +4/-10 switch is set to -10, try setting it to +4.

Gate opens but will not close again- This may be caused by improper Threshold adjustment. Reset the gate as explained in Section 1.6, under **Threshold**.

Gate "chatters"- Reduce Threshold level and/or increase Rate control until a smooth transition occurs.

1.10 3630 SPECIFICATIONS

Dynamic Range: >118dB, "A" weighted

Signal to Noise Ratio: >100dB, "A" weighted

Headroom: +18dBu

Frequency Response: 10Hz to 30kHz, 0/-.5dB

Crosstalk: < -85dB @ 10kHz

Compression Threshold Range: -40 dBu to +20 dBu

Compression Ratio: 1:1 to ∞:1, selectable hard or soft compression knee

Peak Attack Time: 0.1 ms to 200 ms

Peak Mode Release Time: 50 ms to 3 seconds

RMS Average Mode Attack and Release Times: Program dependent

Gate Threshold Range: Continuously open (no gating) to -10 dBu

Gate Rate Time: 20 ms to 2 seconds

Impedance: OUTPUT: 470Ω, unbalanced SIDECHAIN: 2KΩ, unbalanced

Output Gain Control Range: -20 to +20 dB

Nominal Output "Zero" Level: Switchable, +4dBu or -10 dBV

Distortion: Less than 0.05% @ +4 dBu, 20Hz to 20kHz, "A" weighted with 6 dB compression, any switch setting, nominal attack and release times

Indicators: 12 segment gain reduction LED display with -1 to -30 dB range, 12 segment LED input/output (selectable) level display with -30 to +6 dB range, gate open/close LEDs.

Switches: Stereo/dual mono link, bypass, peak/RMS mode, input/output monitor, knee characteristics (hard/soft)

Input and Output Connectors: 1/4" mono phone jacks

Side Chain Connectors: 1/4" stereo phone jacks

Power Requirements: External 9 VAC transformer (supplied), UL approved

Size: Standard 1U rack mount

Note: +4 dBu = 1.23 Vrms -10dBV = 0.316 Vrms

1.11 APPENDIX: About Compression, Limiting, and Noise Gating

Compression and limiting both affect a signal's dynamic range, although in slightly different ways. This type of signal processing can be used as an effect (*e.g.*, increase a guitar or cymbal's sustain) or for more practical applications, such as avoiding tape saturation or restricting the dynamic range of program material for broadcast applications.

(Note: Some of the following is adapted with permission from the book *Guitar Gadgets*, written by Craig Anderton and copyright 1983 by Amsco Publications.)

Limiting

A limiter does not affect the signal going through it until that signal reaches a particular threshold. Above this threshold point, the limiter prevents the signal from becoming any louder by providing as much attenuation as is needed to keep the signal from exceeding the threshold. If the signal drops below the threshold, then the limiter "goes back to sleep" and leaves the signal alone unless it exceeds the threshold again.

The following figures show a signal before limiting. Note how it has a percussive peak and fades out over time.

AMPLITUDE VS. TIME

The next figure shows a signal after limiting, with a dotted line indicating the threshold. Note how the peak has been clamped to the threshold, but the rest of the decay remains unaffected.

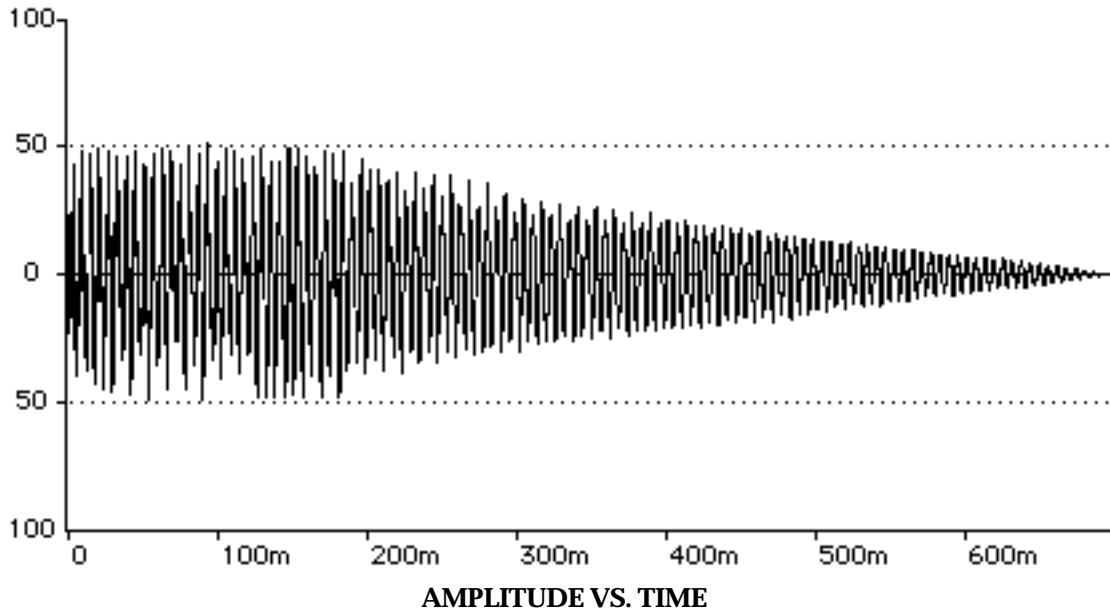

However, the maximum peak signal level has gone from 100 in the first drawing to 50 in the second drawing. Therefore, the overall signal sounds softer. By adding output gain, we can give the limited signal a peak value of 100 again.

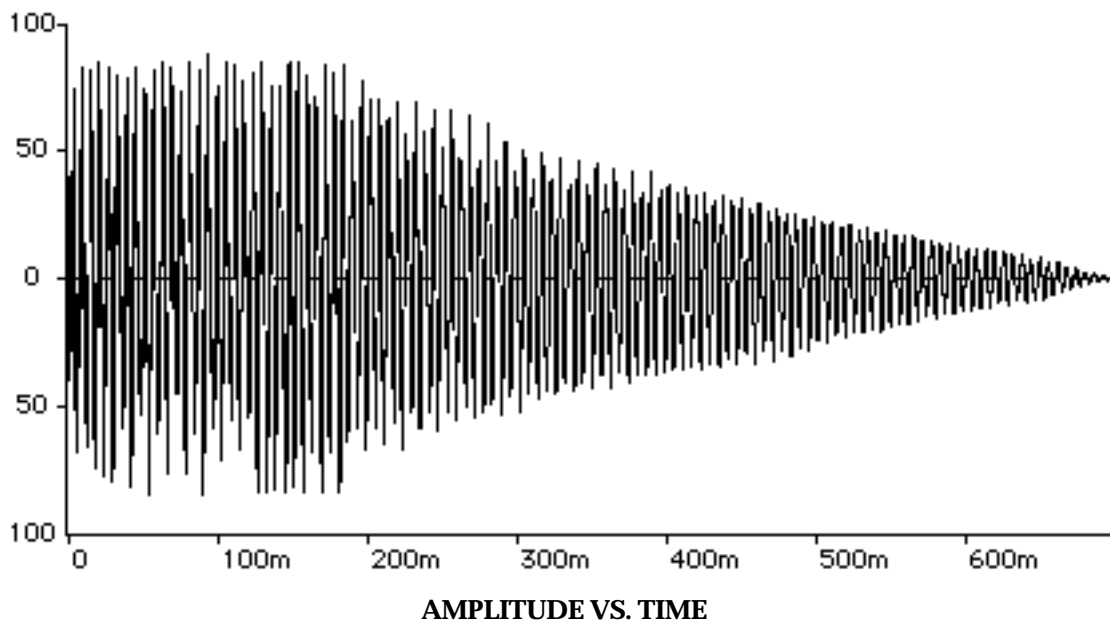

This limited, amplified signal has a much higher average level than the original signal. This is why limited signals can "jump out" at you and have more punch. Commercials, for example, are often heavily limited so that they have as high an average signal level as possible. Radio and TV stations also use limiting to cope with the medium's limited dynamic range.

If the limiter's clamping action occurs abruptly—in other words, the limiter goes from no limiting to full limiting at the threshold point—the sound's output level will not increase despite changes in input level. This is called a *hard knee* response and is often used to eliminate loudspeaker or amplifier clipping.

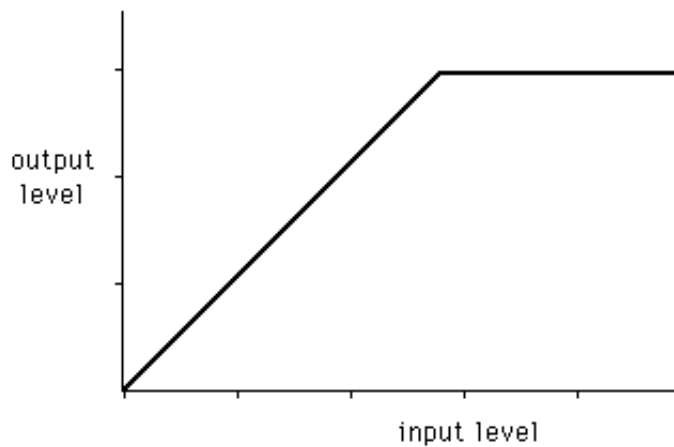

With a *soft knee* response, the limiting action becomes progressively greater past a certain point until it eventually flattens out and clamps the signal fully, just like a hard-knee limiter. This tends to produce a smoother limiting sound that helps smooth out an instrument's dynamic range.

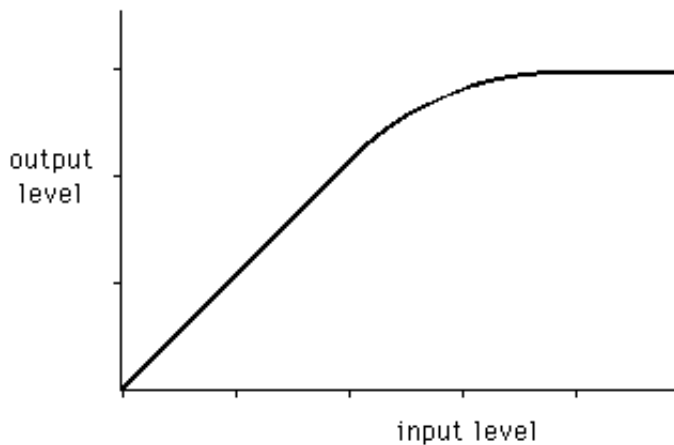

The speed with which a limiter responds to the input signal is also important. If the limiter tries to follow every little nuance of music, the sound can be overly "choppy." Often, you'll want the limiter to affect dynamic range over a somewhat longer period of time. The Release control sets this time period.

Clamping a signal too rapidly can greatly reduce a transient, producing a somewhat dull sound. The Attack control determines how long it takes for the limiter's clamping action to begin.

These controls affect the limiter only when it is in Peak mode, where all limiting is based on the value of signal peaks. In RMS mode, the limiter automatically chooses appropriate attack and release times according to the input signal dynamics.

Compression

Compression is similar to limiting, but rather than clamp all signals to a constant threshold, the output changes at a lesser rate than the input. For example, with a 4:1 compression ratio (as set with the ratio control), a 4 dB input level change produces a 1 dB output level change; an 8 dB input level change produces a 2 dB output level change.

The following figure shows the same signal that was limited earlier, but this time the response has been set for compression. Note how the dynamics of the entire signal are affected, not just those portions above a certain threshold.

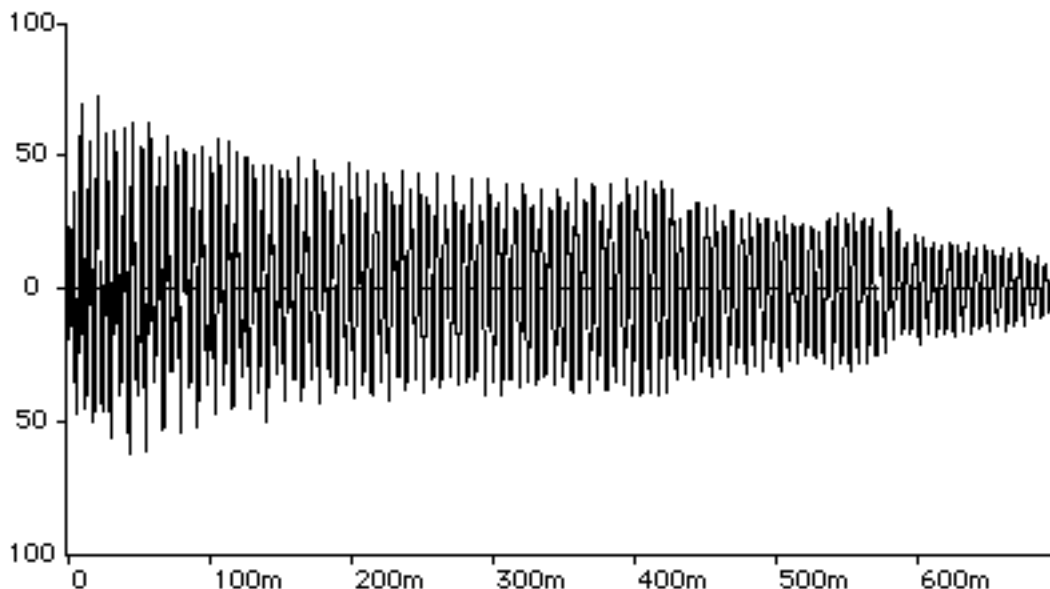

AMPLITUDE VS. TIME

Noise Gating

To understand a gate's principle of operation, consider a "manual noise gate." Suppose you're listening to an audio signal being processed by a relatively noisy effect. As long as the audio signal is present, its level will generally be higher than the noise, thus masking it. However, when the audio signal goes away, the noise is no longer masked and can be heard.

If you connected a volume control after the noisy effect, you could eliminate the noise by turning down the volume whenever there was no audio signal. Then, as soon as the audio signal (which masks noise) returned, you could turn the volume up again.

A noise gate performs a similar function, but automatically. You set a particular noise gate threshold, and the gate compares the input signal level to that threshold. If the input signal exceeds the threshold, the gate acts like a volume control that's all the way up, and lets the signal through. If the input signal is lower than the threshold, the gate acts like a volume control that's all the way down, and blocks the input from reaching the output. If the threshold is set just above the residual noise level, then the gate will be closed whenever there is hiss, thus giving a quieter signal.